

## EHN, EHV

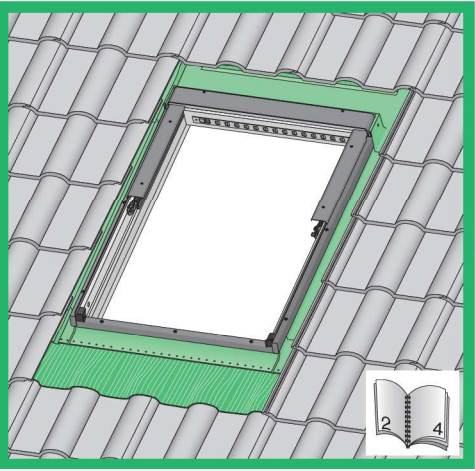

max 90mm

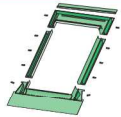
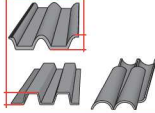

max 45mm

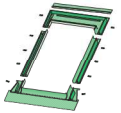

## EZN, EZV, EZJ

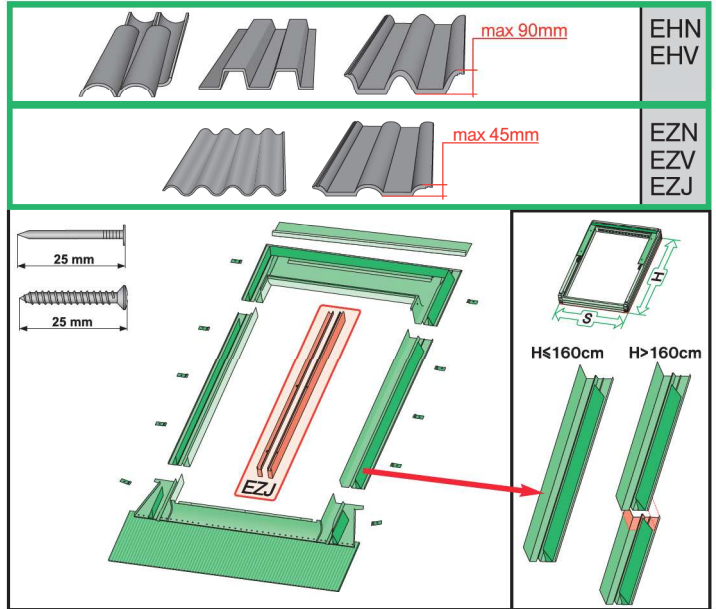

EHN  
EHV

EZN  
EZV  
EZJ

max 90mm

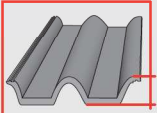

EHN

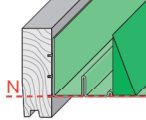

EHV

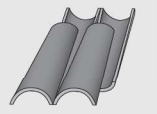
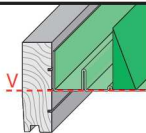

-

-

-

max 45mm

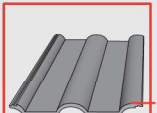

EZN

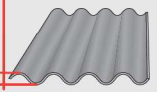
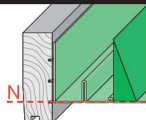

EZV

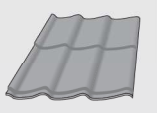
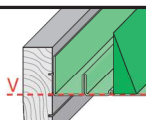

EZJ

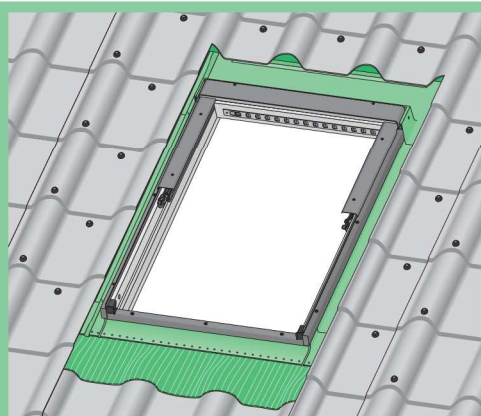
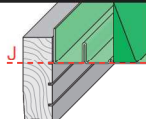

max 45mm

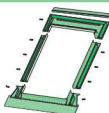
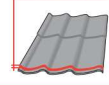

### 1a

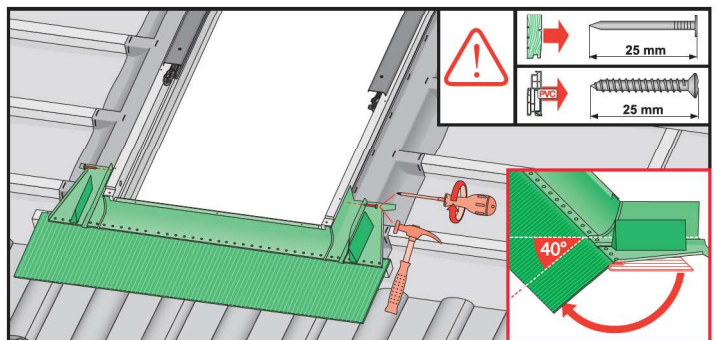
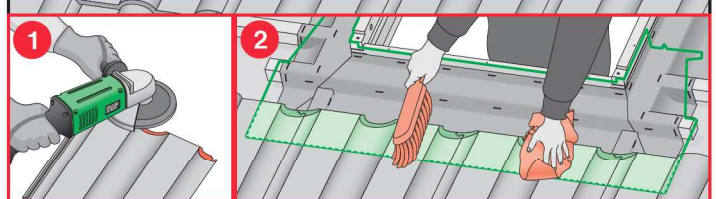
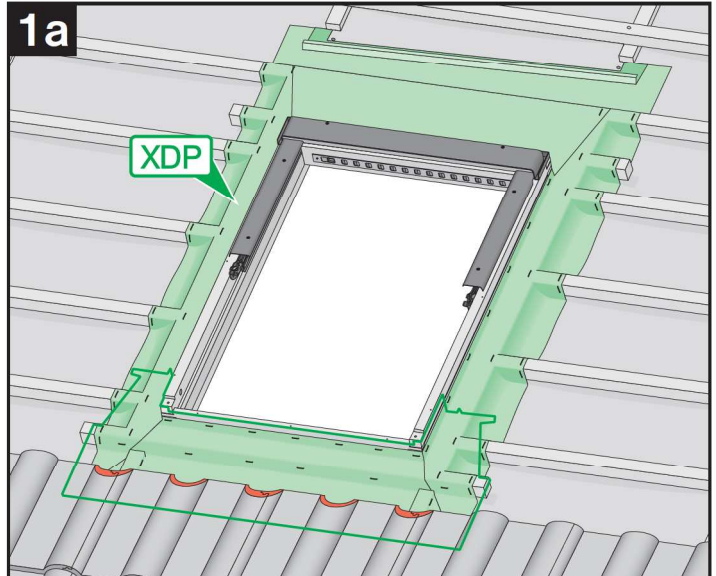

### 1b

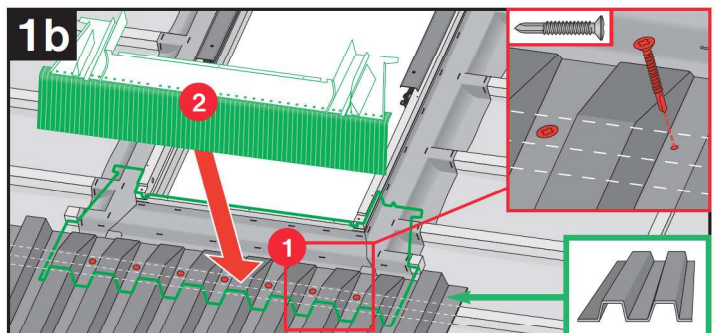



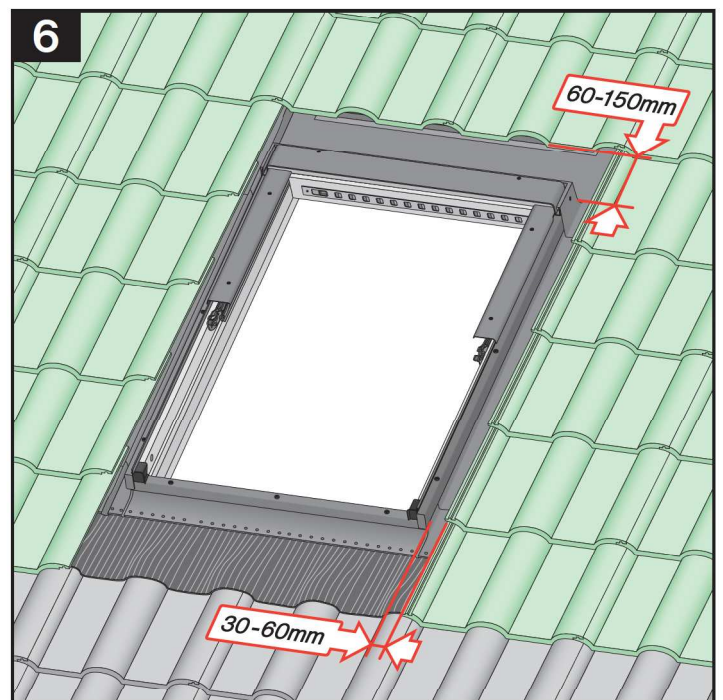
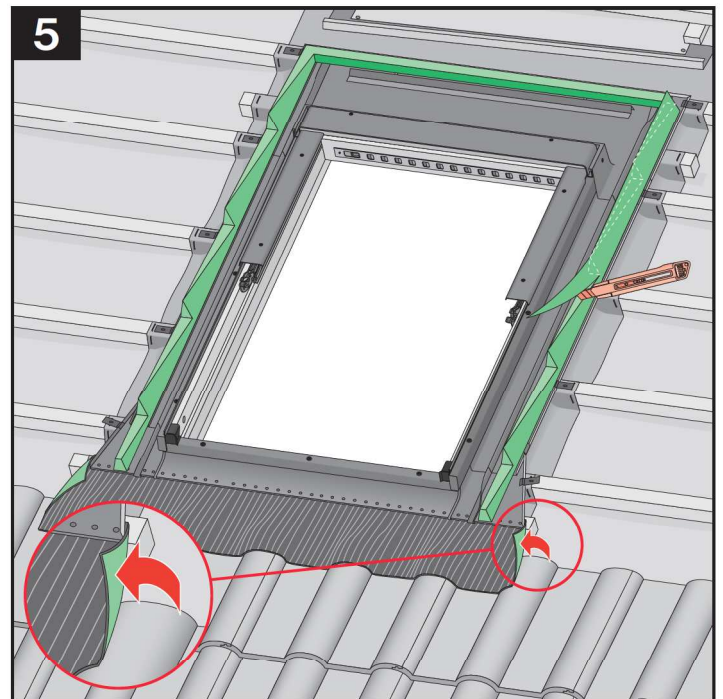
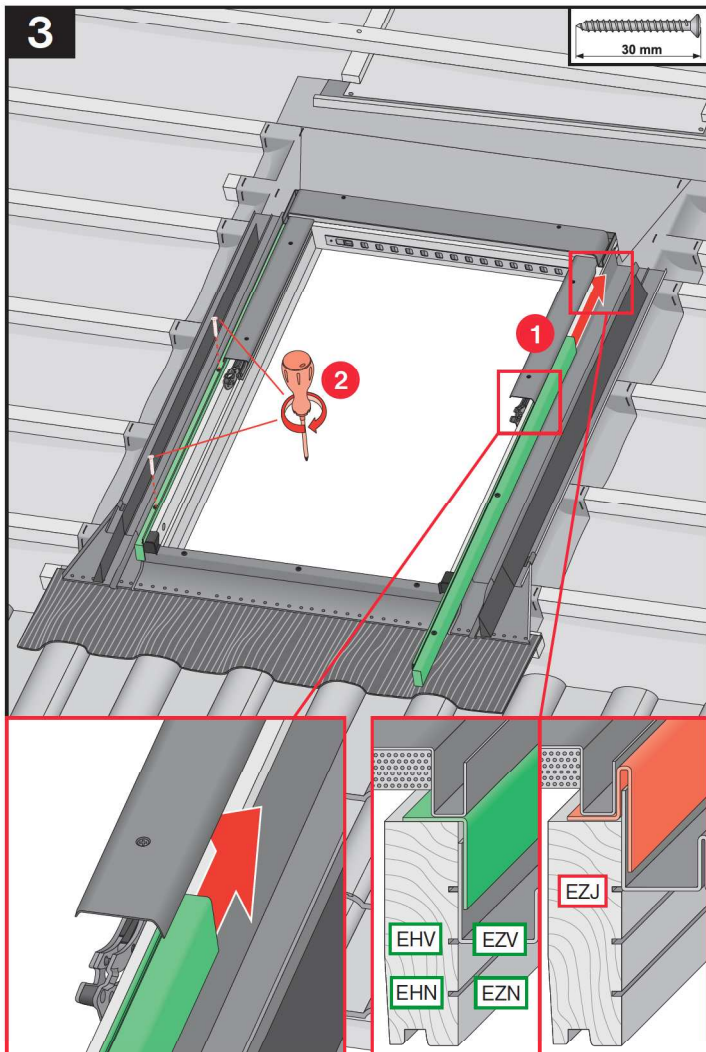
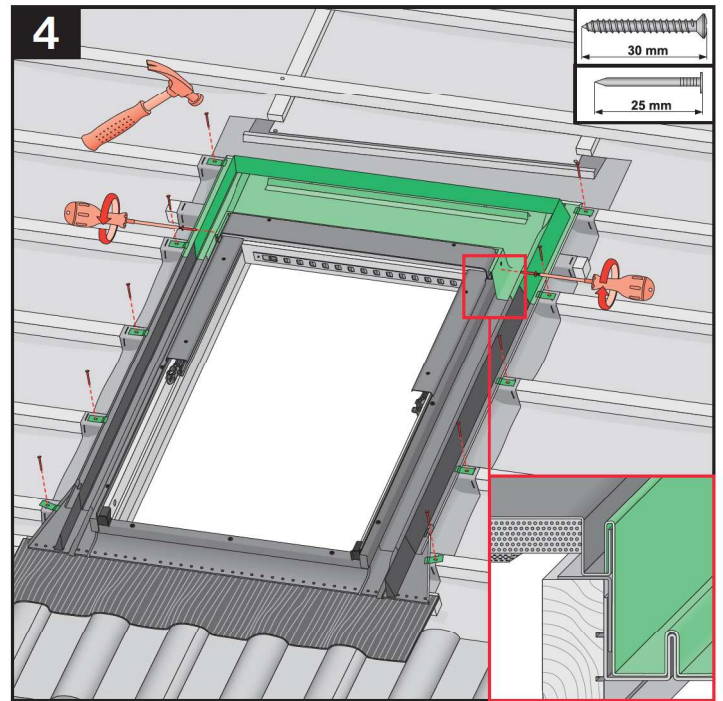
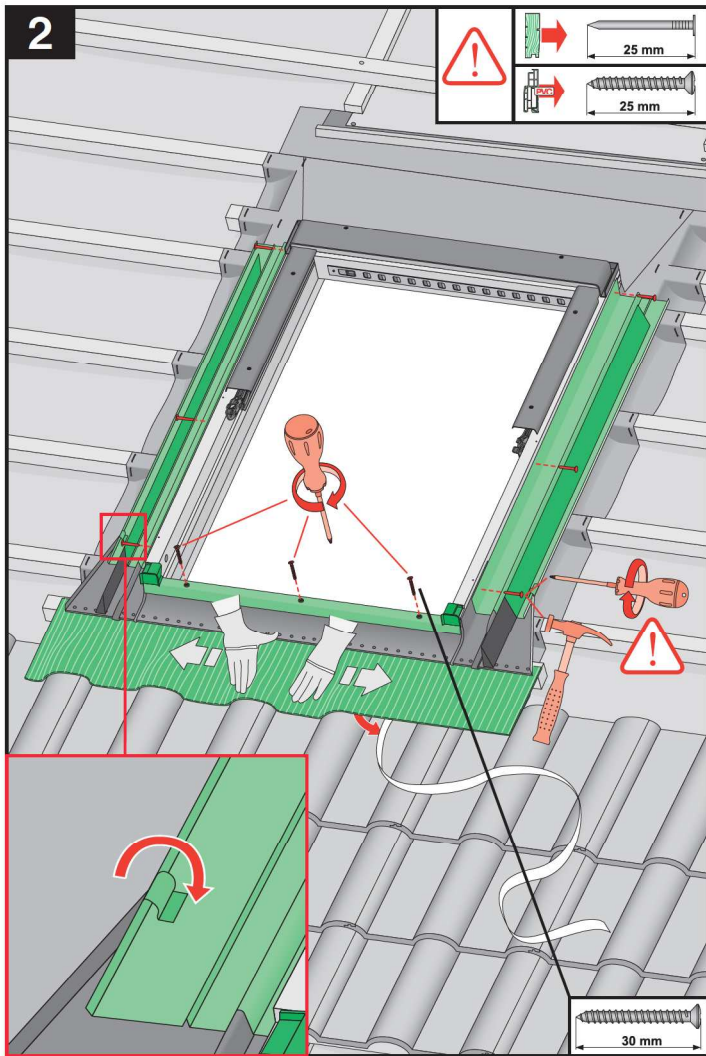



15°-90°

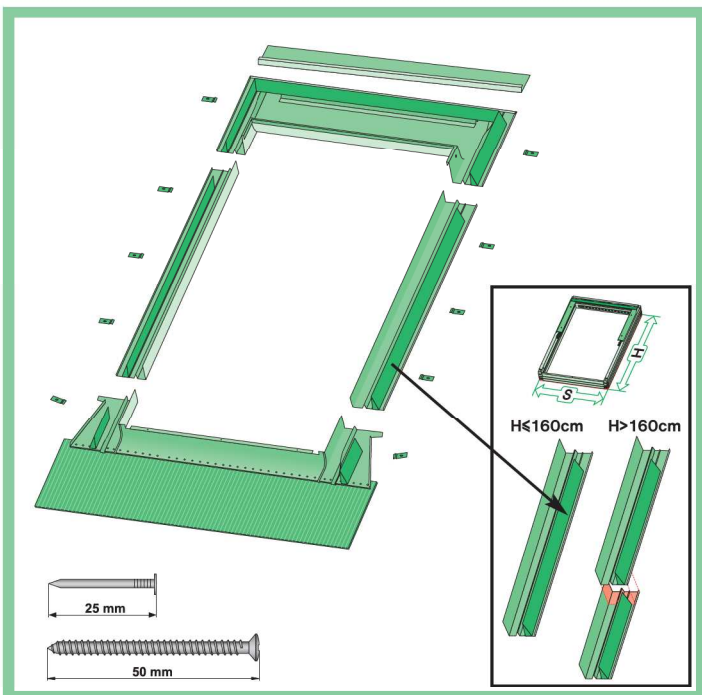
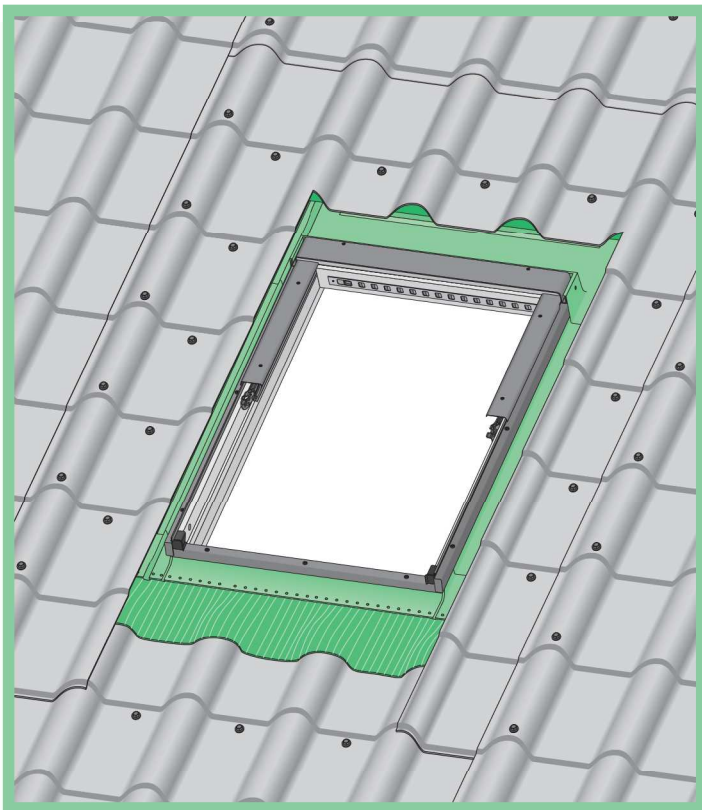
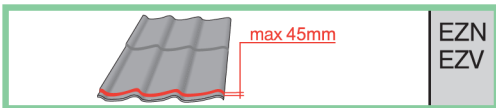

5

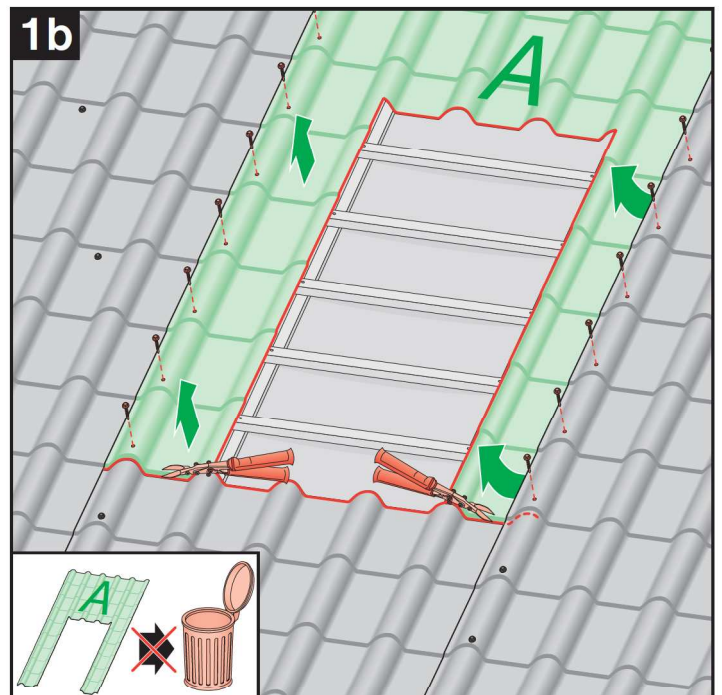
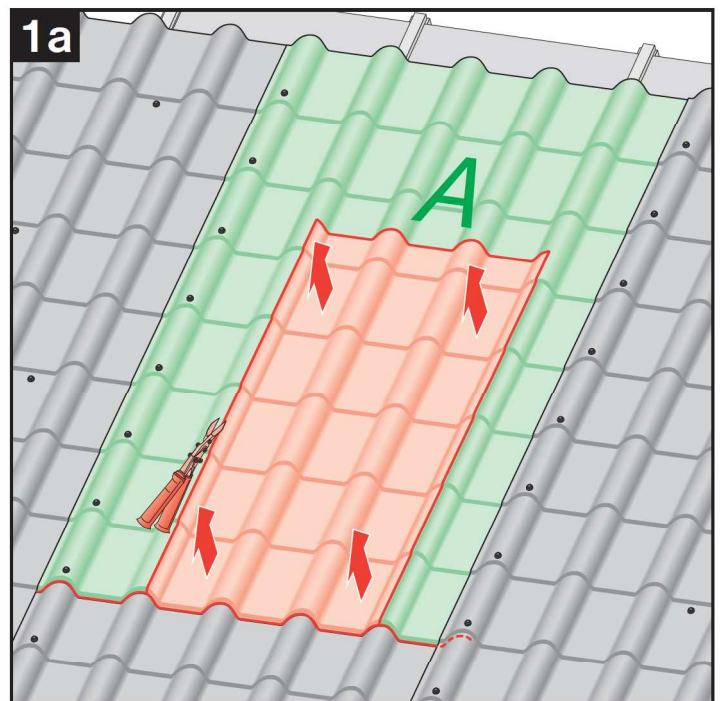
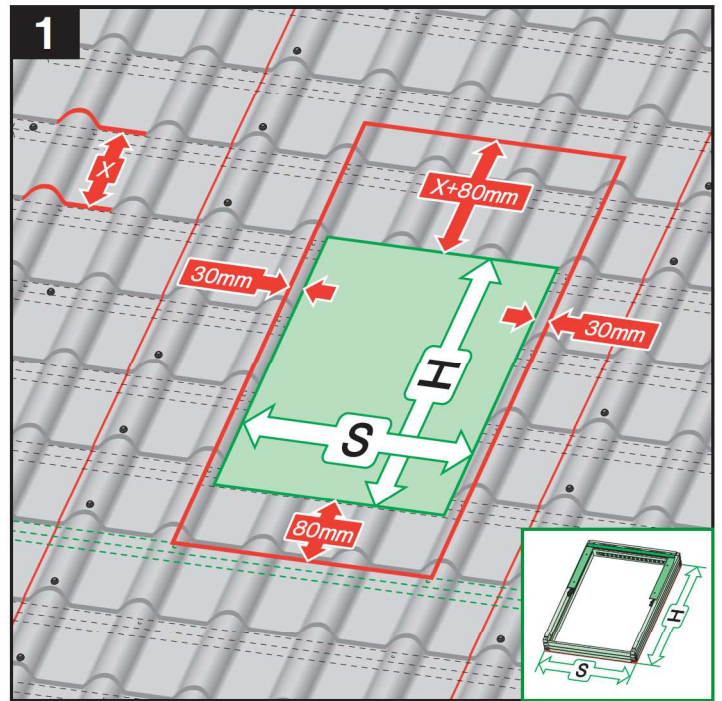

6



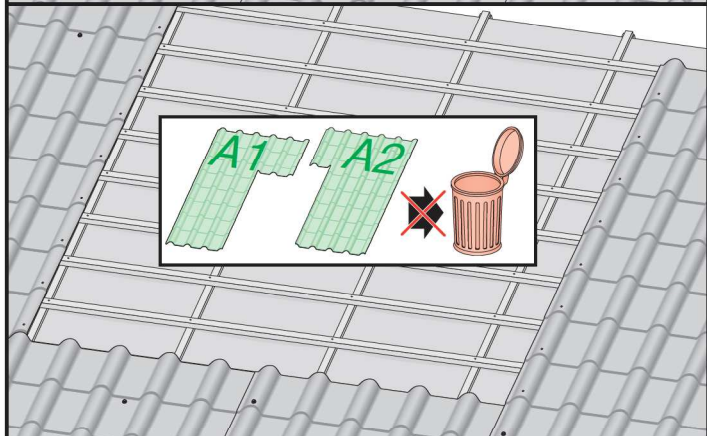
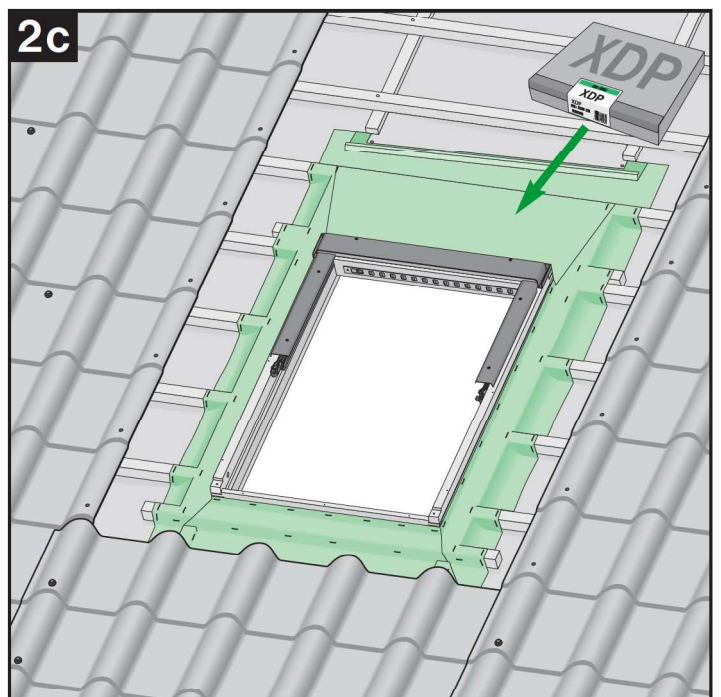
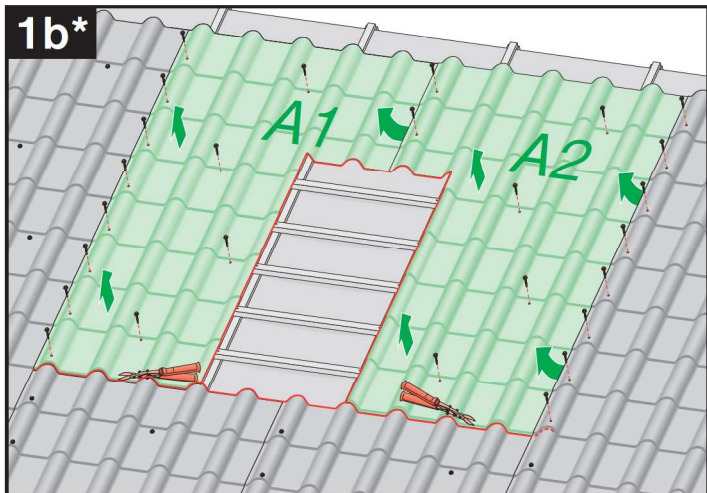
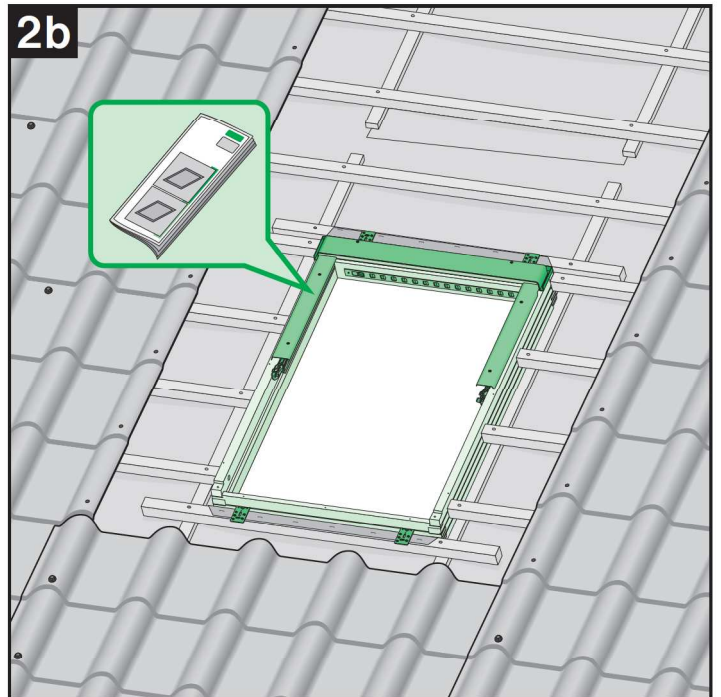
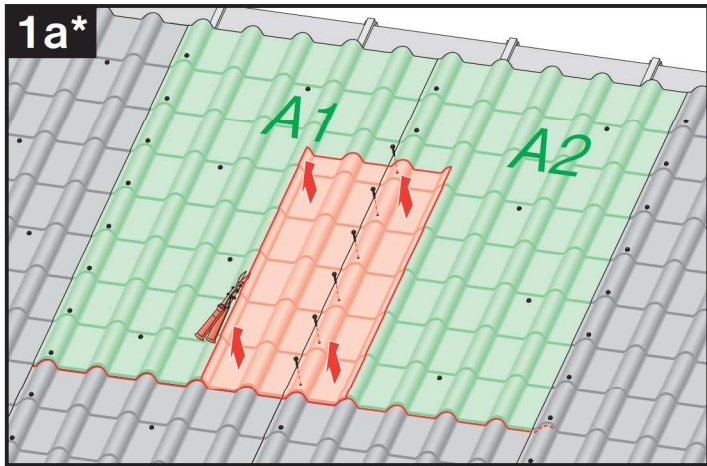
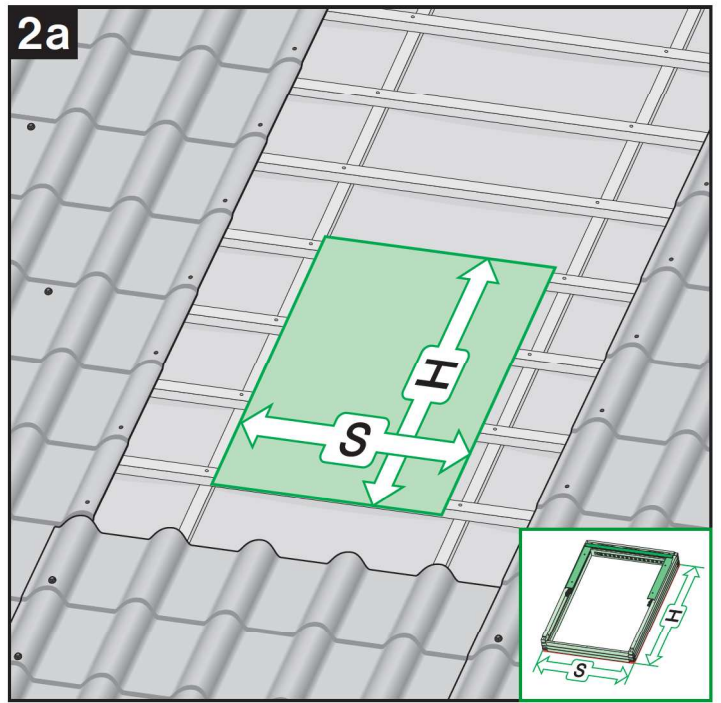
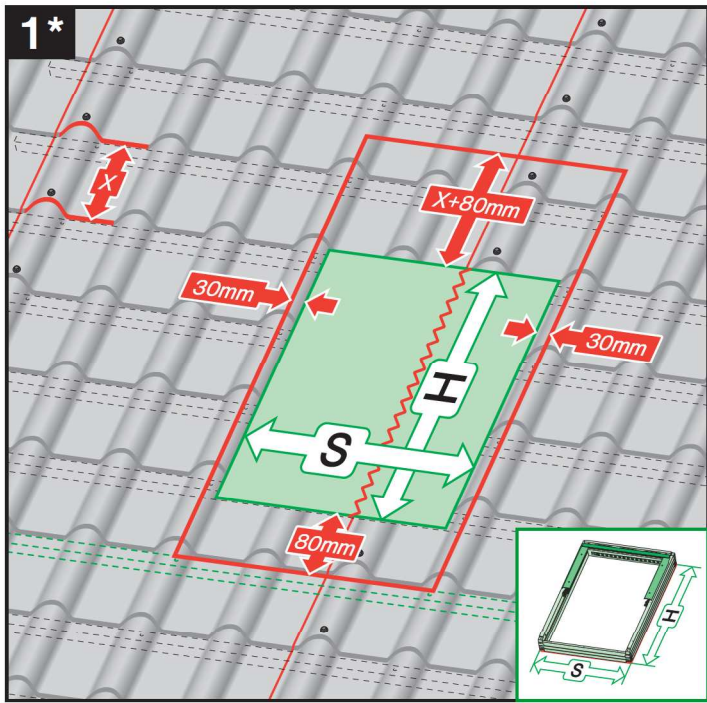



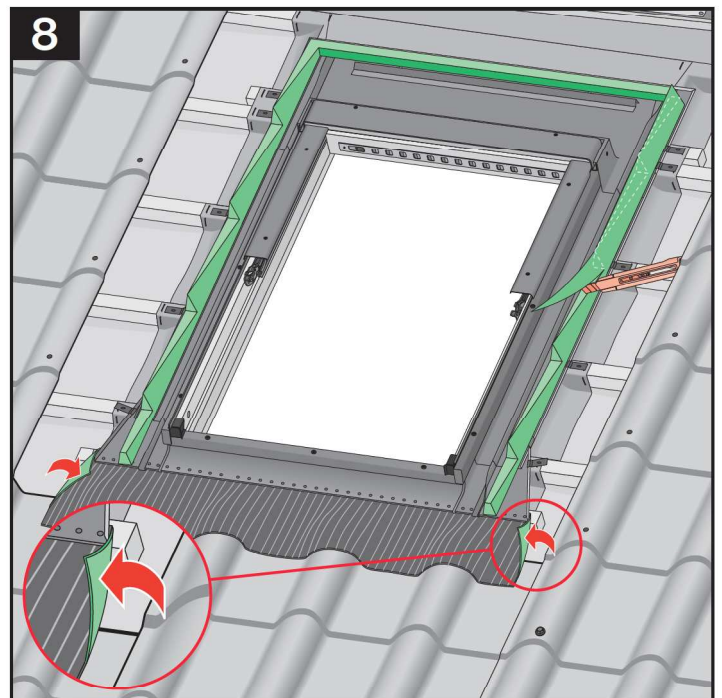
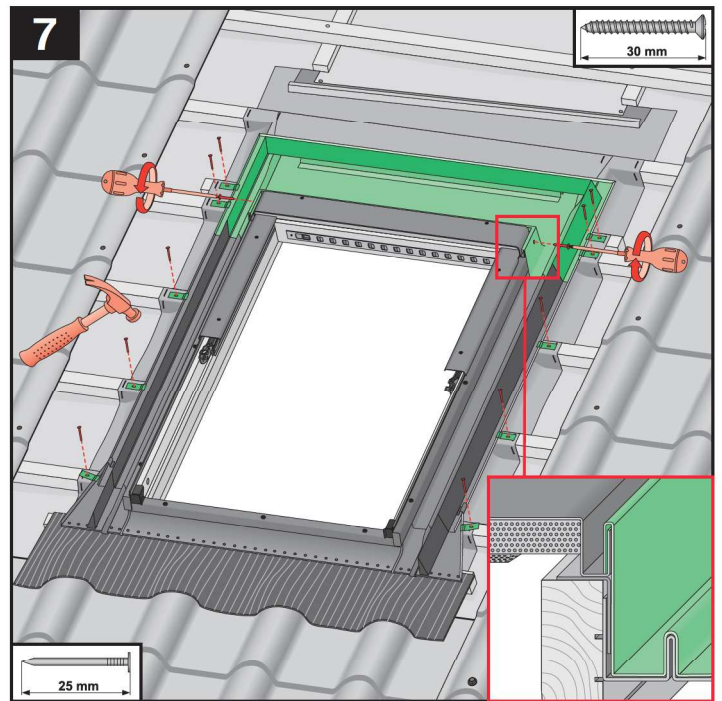
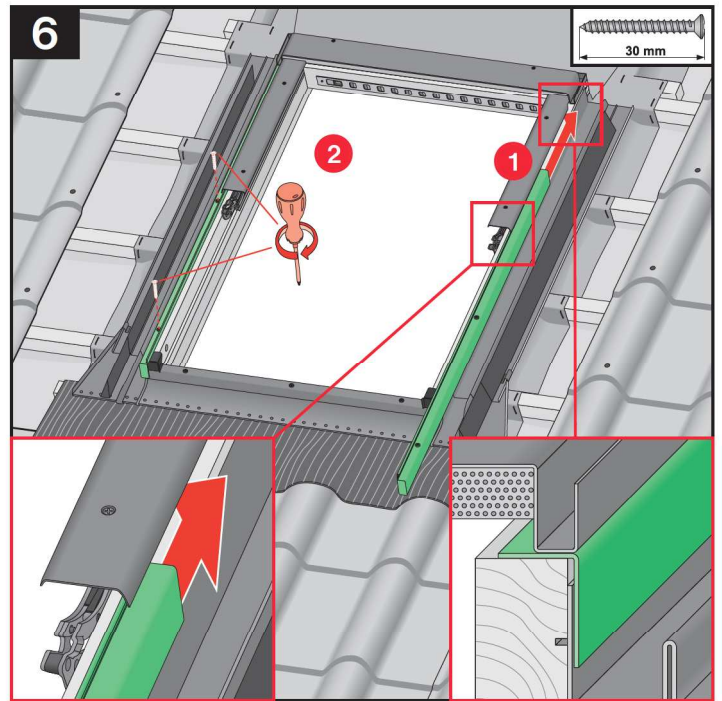
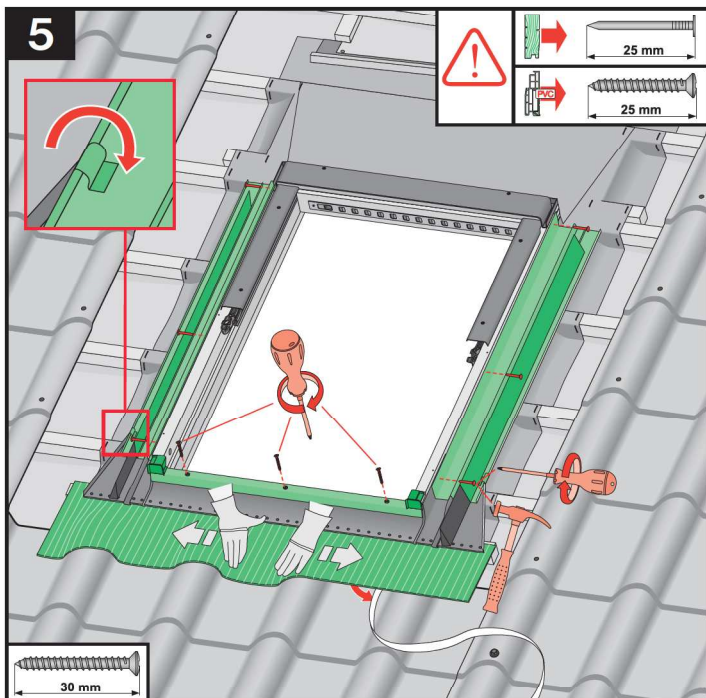
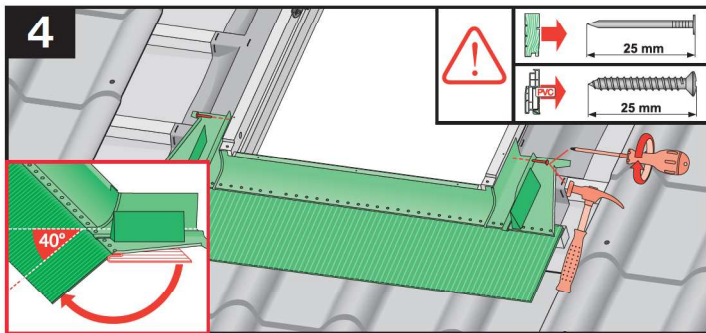
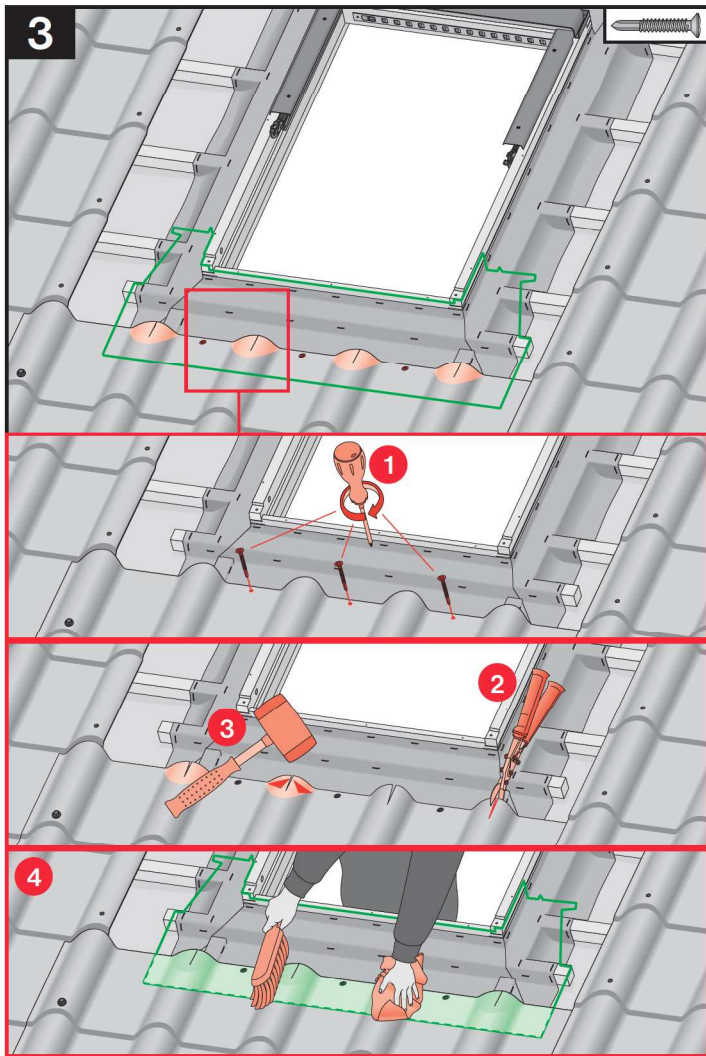



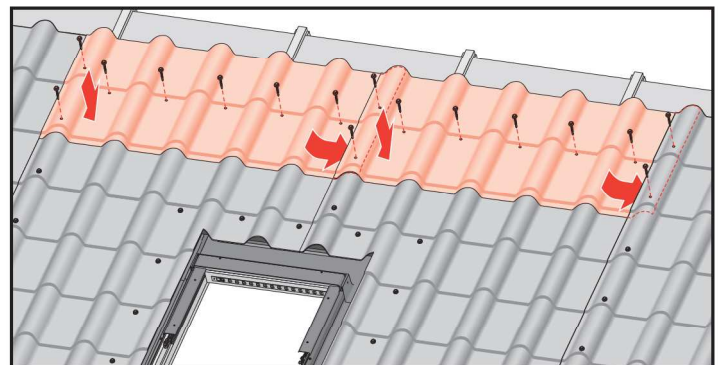
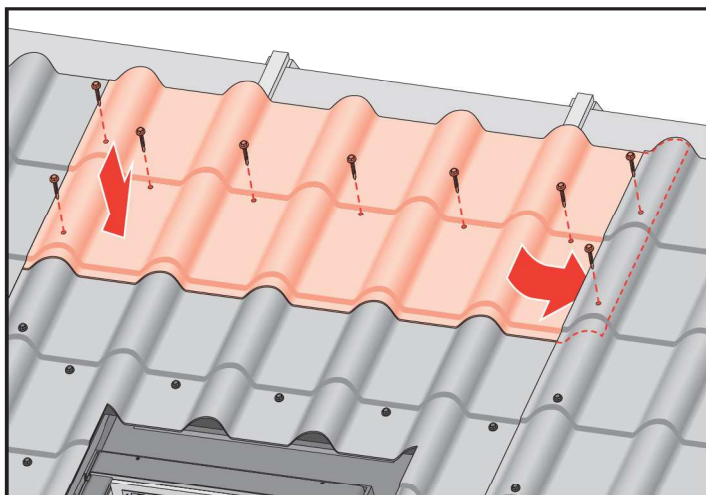
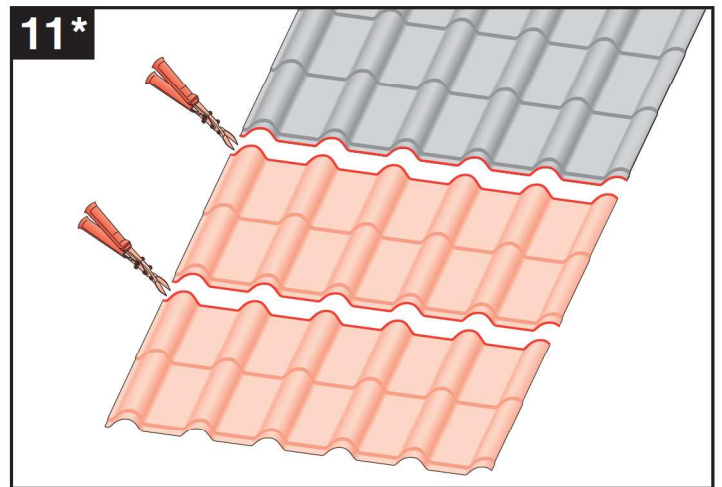
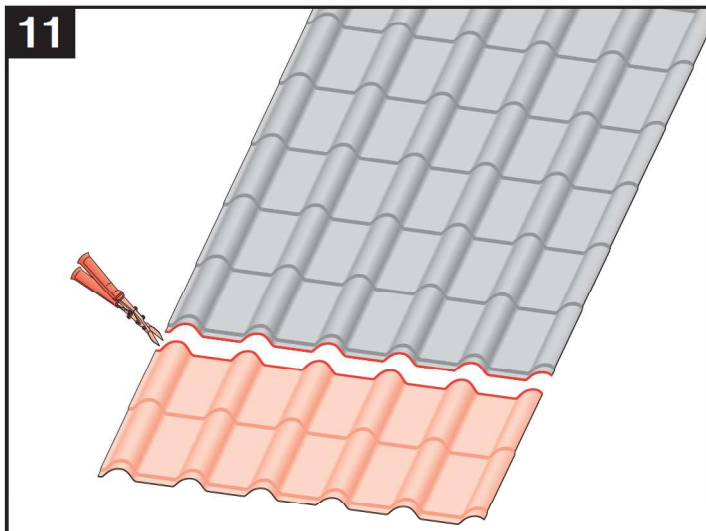
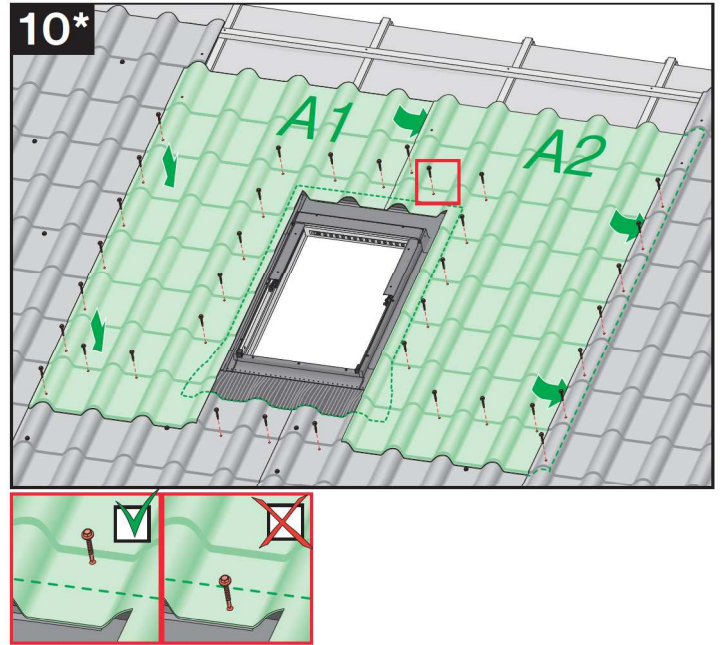
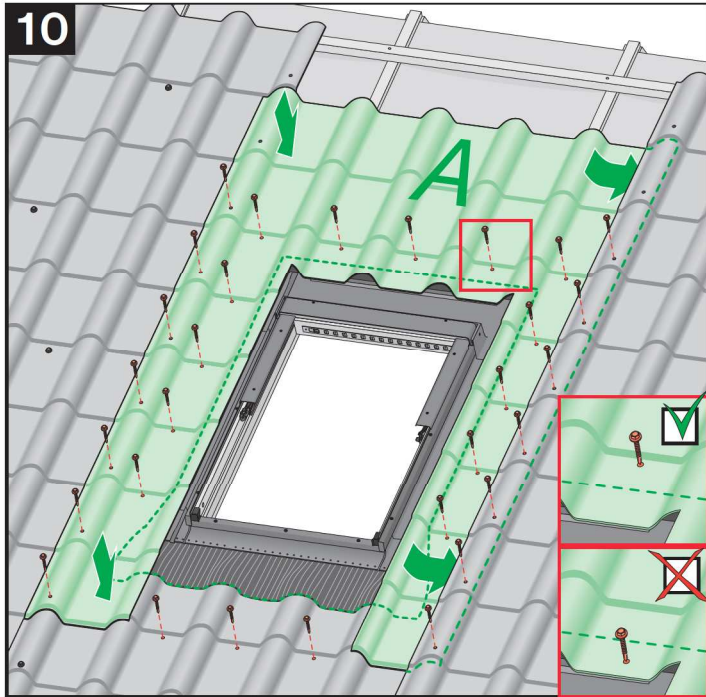
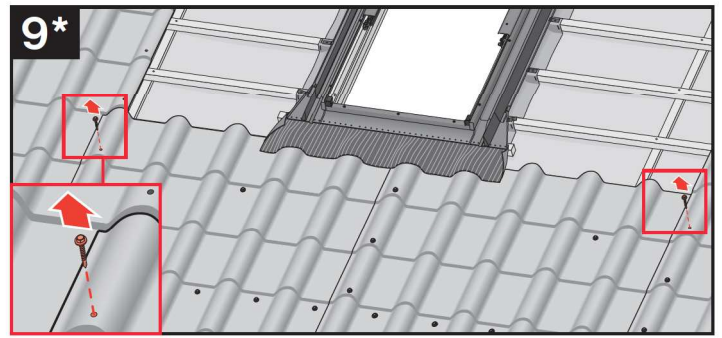
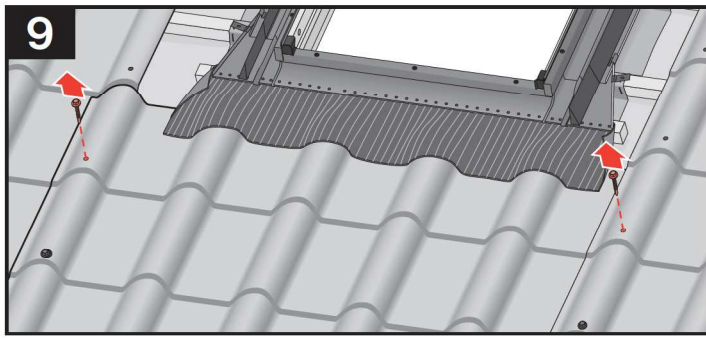

- |           |  |            |  |
|-----------|--|------------|--|
| <b>CZ</b> | Wyrobcze a Prodávce nenese žádnou odpovědnost za nedodržení příslušných předpisů zákona, stavebních předpisů a bezpečnostních požadavků ples uživatele výrobku, architektu, montéra nebo majitele objektu.   | <b>I</b>   | Il Produttore e il Rivenditore non potranno essere ritenuti responsabili per il mancato rispetto, da parte dell'utente del prodotto, del progettista, dell'installatore o del proprietario dell'edificio, delle leggi vigenti, nonché dei regolamenti edilizi e di quelli relativi alla sicurezza. |
| <b>D</b>  | Hersteller und Verkäufer übernehmen keine Haftung für Nichtbeachtung entsprechender Rechts- und Bauvorschriften sowie Sicherheitsanforderungen seitens Produktbenutzers, Architekten, Monteure oder Gebäudebesitzers.  | <b>NL</b>  | De fabrikant en verkoper zijn niet aansprakelijk voor gevolgen bij het niet opvolgen van toepasselijke wetten, bouwbesluiten en veiligheidsvoorschriften door de gebruiker van het product, de architect, de installateur of de eigenaar van het gebouw.   |
| <b>E</b>  | El fabricante y el vendedor no tienen ninguna responsabilidad por el incumplimiento de la ley vigente, normas de construcción y exigencias de seguridad por parte del usuario del producto, arquitecto, instalador o el propietario del edificio.              | <b>PL</b>  | Producent i Sprzedawca nie ponosi żadnej odpowiedzialności za nieprzestrzeganie stosownych przepisów prawa, przepisów budowlanych i wymogów bezpieczeństwa przez użytkownika produktu, architekta, montażystę lub właściciela budynku.   |
| <b>FR</b> | Le fabricant et le revendeur ne prend aucune responsabilité de ne pas respecter les lois applicables, les règlements sur les bâtiments et les exigences de sécurité par l'utilisateur du produit, l'architecte, l'installateur ou le propriétaire du bâtiment. | <b>RU</b>  | Ни производитель, ни дистрибутор не несут ответственности за несоблюдение действующих в настоящее время законодательных, строительных и требований безопасности при использовании продукта, архитектором, монтажником или владельцем здания.   |
| <b>GB</b> | Manufacturer and Seller shall bear no liability for failure to comply with the applicable laws, building codes and safety requirements by the user of the product, architect, fitter or owner of the building.   | <b>RUS</b> | Производитель и продавец несут ответственность с производителя и продавца с соблюдением правил и норм безопасности при использовании продукта, архитектором, монтажником или владельцем здания.  |
| <b>H</b>  | A Gyártó és a Forgalmazó nem vállal semmilyen felelősséget a vonatkozó törvényi, építési és biztonsági előírások, terméktulajdonosi, építési, beszállómester vagy építéltulajdonos által nem tartásáért.   | <b>SK</b>  | Výrobca a predávca neniesi žádnú zodpovednosť za nedodržanie príslušných ustanovení zákona, stavebných predpisov a bezpečnostných požiadaviek užívateľom výrobu, architektom, montérom alebo majiteľom objektu.  |